

Phoenix

DESIGNED FOR YOU

Technical Data Sheet

Range: Accessories

Type: A09 Series

Code: A09003

Version/Date: v1 01/17

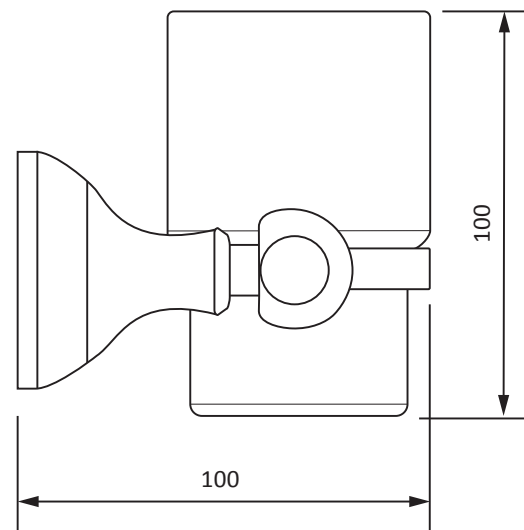
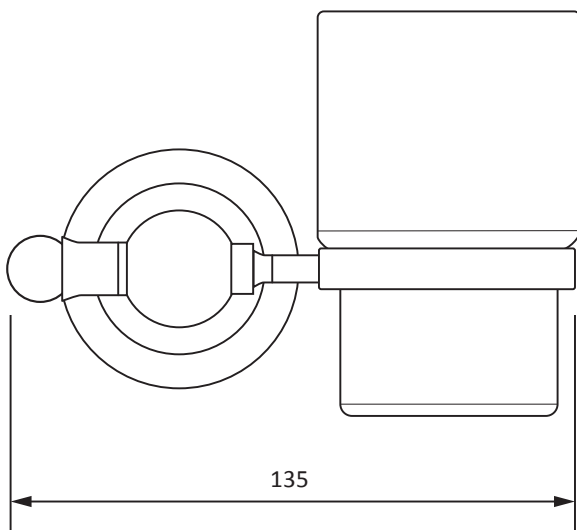

Guarantee/Aftercare: During installation extra care must be taken to avoid damaging the fittings. We provide a guarantee against faulty manufacture or materials (excluding serviceable parts), providing they have been installed, cared for and used in accordance with our instructions and good plumbing practice.

Phoenix Whirlpools Ltd. Unit 8, Leeds 27 Industrial Estate, Bruntcliffe Ave. Morley, Leeds LS27 0LL

Tel: (Sales) +44 (0)113 2012260 Fax: +44 (0)113 2012268 Email: sales@phoenix-uk.co.uk Web: www.phoenix-uk.co.uk

Notes: Drawings may not be to scale. All dimensions in mm unless otherwise stated. Information correct at time of printing but subject to change at any time.